



DC50 Digital Dispenser Operating Manual

info@fisnar.com

www.fisnar.com

Table of Contents

Machine Overview	3
Product Safety Statements	4
Specifications	6
Accessories	6
External Controls	7
Machine Setup	11
Dispense Setup	12
Dispense Modes	13
• Manual Mode	13
• Timed Mode	14
External Machine Actuation	18
Spare Parts List	19

OVERVIEW



Model DC50 Digital Dispenser

The DC50 is a general purpose, reliable and easy to use digital dispenser with a bright 4-digit timer control display for precise & repeatable dispensing.

The simple user-friendly programming enables a dispense cycle to be quickly created and automatically display.

It is perfectly suited for a wide variety of dispensing applications; from microdot deposits, to large potting and filling.

Two Operation Modes

A manual mode – The dispense operation is manually controlled by a foot pedal.

A timed mode – Dispenses at a pre-set time for controlled, repeatable shot sizes.

One programmable memory slot.

Adjustable air output pressure (0-100psi) and vacuum function with digital timer display (0.008-99.99 seconds).

Suitable for dispensing both low and high viscosity fluids.

Adjustable vacuum suckback control prevents low viscosity fluids dripping from dispense tip.









Industry standard ¼” air-output connector ensures universal compatibility with syringe barrel adapter heads.

Compact & durable aluminum housing designed for industrial work environments.

Worldwide compatible power supply.



SAFETY

General Precautions

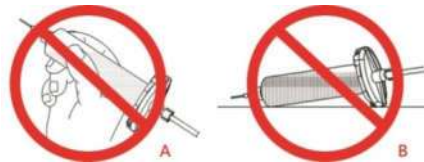
	<i>Do not operate the machine in excess of its maximum ratings / settings.</i>
	<i>Make sure that the input air supply is clean and dry. A 5 micron air filter/regulator (item number 560567) is recommended to ensure the input air supply is clean and dry.</i>
	<i>If corrosive or flammable fluids are being used, an inline filter (item number 5606037) must be installed to help prevent the fluids from being sucked back into the machine.</i>
	<i>The fluid being dispensed may be toxic and / or hazardous. Refer to the Material Safety Data Sheet for proper handling and safety precautions.</i>
	<i>Do not smoke or use near an open flame when flammable materials are being dispensed.</i>
	<i>Do not expose the machine directly to sunlight.</i>
	<i>Avoid cleaning the machine with aggressive solvents – neutral detergents are preferred.</i>
	<i>Do not overfill the syringe barrel and/or lay the syringe barrel on its side. This will prevent fluids from flowing back into the machine – refer to figures A & B below.</i>



DC50 Malfunction

	<i>If the machine malfunctions, shut down the machine immediately. This can be done by either pushing the power switch at the back of the unit into the off position or disconnecting the power cord.</i>
	<i>Always use a piston with the syringe barrel to prevent fluids from flowing back into the machine</i>
	<i>When dispensing low viscosity fluids that require the vacuum, be aware not to increase to a point where fluids begin to run back into the air line potentially reaching the control box. The vacuum should not be set too high or it will cause material to creep backwards.</i>

SAFETY

Inappropriate Use

If the machine is used in a way other than described in this manual, it may cause damage to self or property.



Do not use any components with the machine other than Fisnar authorized components.



Do not use incompatible materials.



***Do not make any modifications to the machine.
All repairs are to be done using Fisnar specified spare parts.***



Do not operate the machine in excess of its maximum ratings / settings.

Fire Prevention

Refer to the following instructions to avoid any fire or explosion.



Assess your surroundings and the location of the nearest fire extinguisher and Emergency Exit.



Do not smoke or use near an open flame when flammable materials are being dispensed.



Immediately disconnect power if any sparking or smoke appears.



Do not expose the machine directly to sunlight.

Maintenance

The DC50 is generally a maintenance free machine. However, to ensure smooth operation please follow the below instructions.



Only use non-woven cleaners on the machine.



Avoid cleaning the machine with aggressive solvents – neutral detergents are preferred.



Ensure that compressed air supply to the machine is clean and moisture free.



Do not lay the barrel on its side. This will prevent fluids from flowing back into the machine.

SPECIFICATIONS

Dimensions (W x D x H):	7.56" x 5.04" x 3.00" (192 x 128 x 76 mm)
Weight:	2.14 lbs (0.97 kg)
Input AC to Power Supply:	100 – 240 VAC, 50 / 60 Hz
Output DC from Power Supply:	24 VDC – 1 Amp
Cycle Rate:	Up to 600 cycles / min
Relative Humidity:	20 – 90% (No Condensation)
Operating Temperature:	50 – 104°F (10 – 40°C)
Timer:	0.008 – 99.99 seconds
Air Input:	100 psi (7 bar) max
Air Output:	1 – 100 psi (0.07 – 7 bar)
Standards:	CE Approved, RoHS Compliant, EMC Compliant

ACCESSORIES

Item	Description	Quantity
5601911	Power Adaptor (Input: 100 – 240 VAC / Output: 24 VDC)	1
5601888	Foot Pedal	1
561851	Air Inlet Hose Assembly	1
560751LF	Syringe Holder	1
5779K712	Push To Connect Tube Fitting 1/4" Stem OD X 5/32" Tube OD	1

Note: Consumable kit (part # QK-CSK) & needle sample kit (part # QK-NSK) available to purchase separately.



Part # QK-CSK



Part # QK-NSK

EXTERNAL CONTROLS

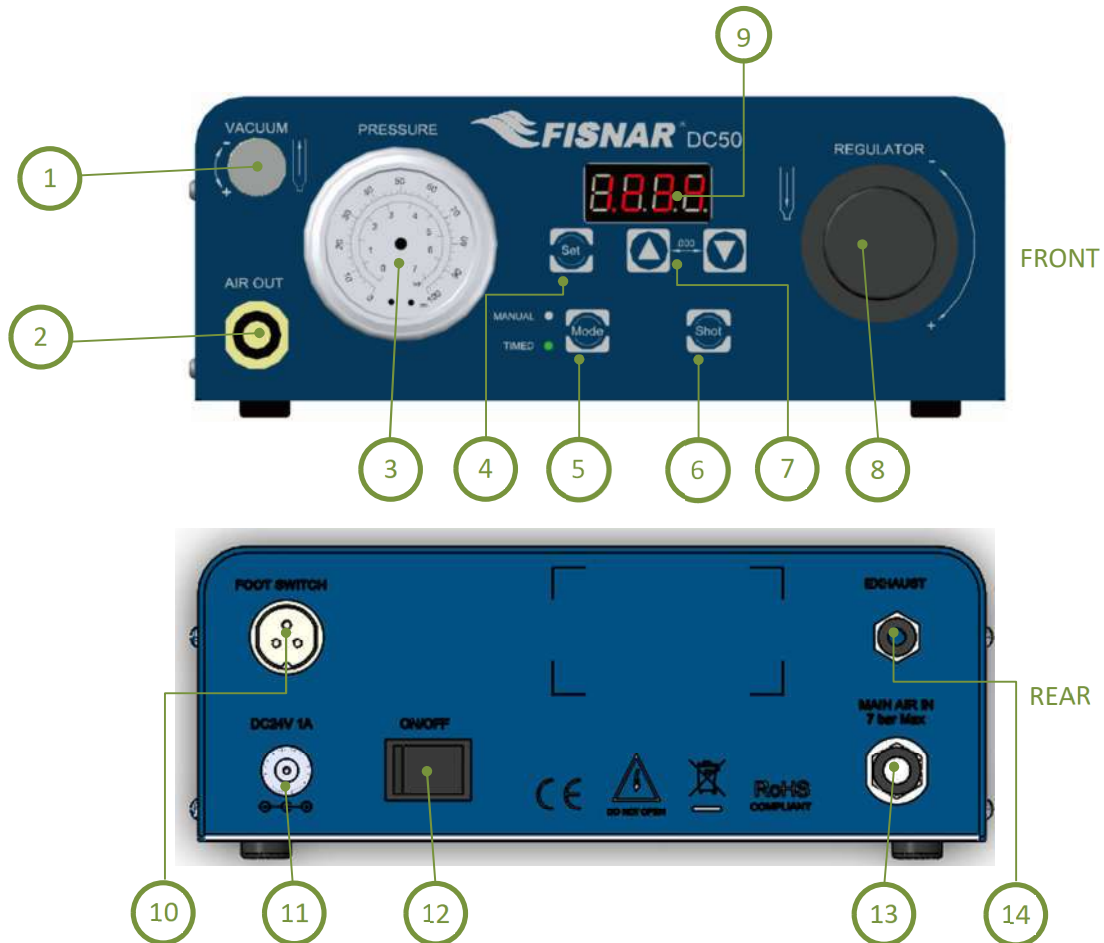

FIG. 1: External Controls - Overview

Item	Illustration	Item	Illustration	Item	Illustration
1	Vacuum Control	7	Scroll Buttons	13	Air Inlet Port
2	Air Outlet Port	8	Air Pressure Regulator	14	Exhaust Port
3	Air Pressure Gauge	9	Display		
4	Set Button	10	Foot Switch Connector		
5	Mode Button	11	Power Input Connector		
6	Shot Button	12	Power On/Off Switch		

EXTERNAL CONTROLS



FIG. 2: External Controls – Front

1.	Suck Back Control	Keeps a negative air pressure in the syringe barrel when not dispensing. Required to prevent low viscosity fluids dripping from the dispense tip in between dispense cycles.
2.	Air Out Push Connector	The syringe barrel adapter head assembly is connected here.
3.	Pressure Gauge	Shows the amount of pressure being used to dispense fluid from the syringe barrel.
4.	Digital Display Screen	<p>When in MANUAL mode, it will count up from 0.000 seconds for as long as the foot pedal switch or shot button is pressed. When the foot pedal switch or shot button is released, it will display and hold the dispense cycle time until the next actuation cycle. When the foot pedal switch or shot button is pressed again, the timer will automatically reset and start counting up from 0.000 seconds.</p> <p>When in TIMED mode, it will display the currently saved dispense time (seconds). When the foot pedal switch or shot button is pressed, the machine will automatically start counting up from 0.000 seconds until it reaches the saved dispense time.</p> <p>One (1) individual program is saved to the machine and automatically recalled when the machine is powered on.</p>
5.	Pressure Regulator	Adjusts the amount of pressure being used to dispense fluid from the syringe barrel. In order to reach the desired pressure, pull the knob outwards to unlock it, so it will rotate freely. Turn the knob counterclockwise to a point below the required pressure, and then turn the knob clockwise to reach the required pressure.

EXTERNAL CONTROLS

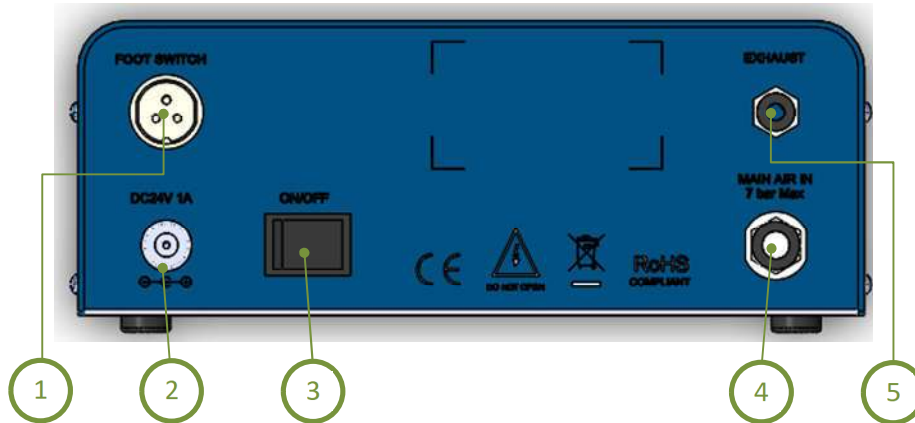





FIG. 3: External Controls - Back

1.	Foot Switch Connector	The foot pedal switch is connected here. Or it can be used for connecting to an external device (e.g. Fisnar dispense robot) that will send the dispense start signal to the machine.
2.	Power Input Connector	Power input cable from the external power supply is connected here.
3.	On / Off Switch	Used to switch the machine on or off.
4.	Air In Push Connector	External Compressed air 70-100 psi (5-7 bar) is to be connected here, using the supplied ¼" OD air inlet hose.
5.	Exhaust	When the suck back control is in use, air will be exhausted from this connector in between dispense cycles. A muffler (item number 560024) can be fitted into the exhaust outlet port to reduce the emitted noise of the exhausted air.

EXTERNAL CONTROLS



FIG. 4: Control Buttons

<p>Switch Modes</p>	<p>Press the  button to switch between the two different dispense modes (MANUAL or TIMED). A green LED light will alight next to the text “MANUAL” or “TIMED” to identify the current dispense mode that the machine is operating in.</p>
<p>Change / Set Dispense Time</p>	<p>Press the  button in order to change the dispense time. It is then used as a scroll button to move between the numerical digits showing on the digital display screen.</p>
<p>Adjust Dispense Time</p>	<p>Press the  button to increase or decrease the dispense time.</p>
<p>Dispense Shot</p>	<p>Press the  button to actuate the machine and begin fluid dispensing.</p>

MACHINE SET UP

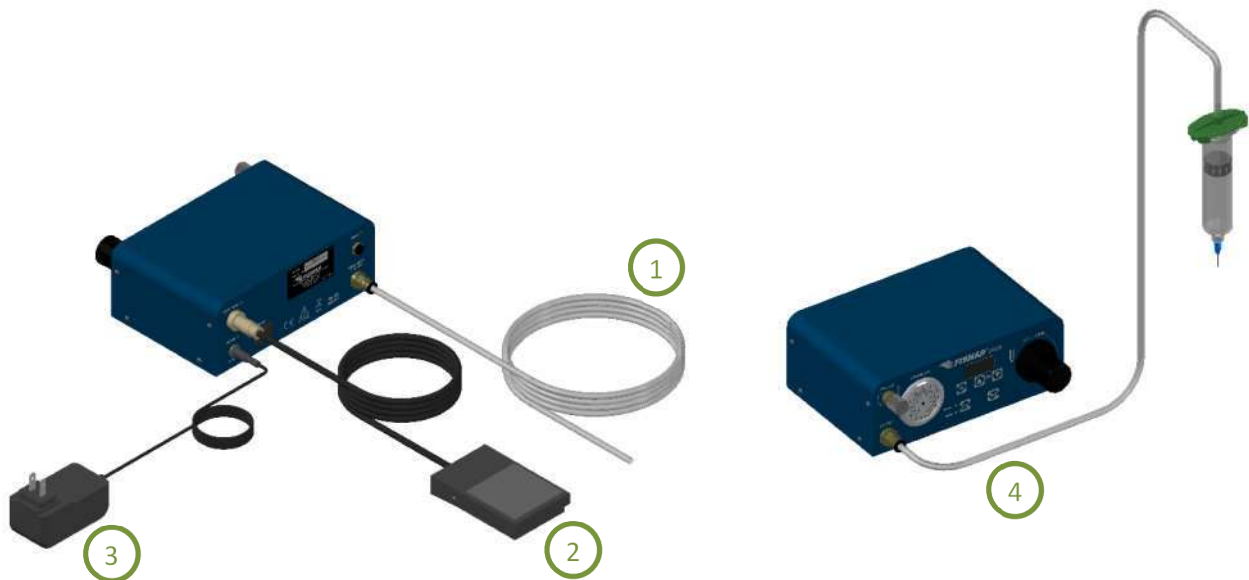

FIG. 5: Front and Back Views

1.	Connect air hose (1) from compressed air 70-100 psi (5-7 bar) to the air inlet port on the back of the machine. See FIG. 5.
2.	Insert the Foot Pedal connector (2) to the port on the back of the machine. See FIG. 5.
3.	Attach appropriate country type plug adapter onto the power supply and then connect Electrical Power Cord (3) to the port on the back of the machine. See FIG. 5.

DISPENSE SETUP

Fill the syringe barrel (with syringe barrel tip cap fitted on the syringe barrel) with the fluid material to be dispensed. Once filled, correctly insert piston into syringe barrel. Attach syringe barrel to syringe barrel adapter head as shown below. See FIG. 6.



Do not overfill the syringe barrel and/or lay the syringe barrel on its side. This will prevent fluids from flowing back into the machine – refer to figures A & B below.

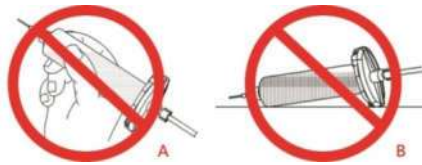

1.	Connect the syringe barrel adapter air tube to the “Air Out” port on the front of the machine. (4) See FIG. 5. Can be standard use with Fisnar adapter head assemblies supplied with green color push to connect fitting (5606038).
2.	If the syringe barrel adapter to be used with the machine has a bayonet fitting attached to the end of it, make sure to cut the bayonet fitting off from the hose. Use adapter 5779K712 push to connect air fitting (1/4” stem x 5/32” tube O.D.) with the air-line when installing the hose into the air out fitting in the front of the machine.

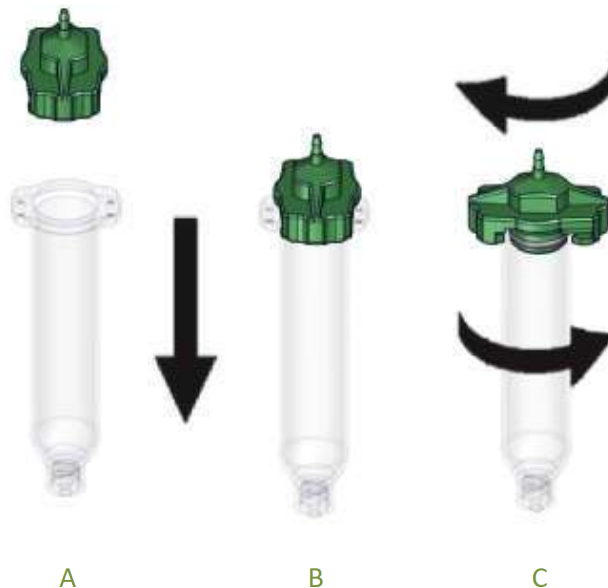

FIG. 6: Dispense Setup

DISPENSE MODES



FIG. 7: Dispense Modes

MANUAL MODE

1.	<p>Use the button to switch to MANUAL mode.</p> <p>MANUAL mode allows the operator to actuate the machine on demand whenever the dispense signal is activated (i.e. foot pedal is pressed).</p>
2.	<p>Press the foot pedal or button to start the machine and begin dispensing.</p> <p>Release the foot pedal or button to stop dispensing.</p> <p>The machine will count the amount of time you are dispensing whilst the foot pedal or button is pressed. This may be helpful in determining a time to be used when programming in TIMED mode.</p> <p>The TIME shown on the digital display after the foot pedal or button has been released, will reset to zero (0) seconds every time the machine is actuated.</p>

DISPENSE MODES

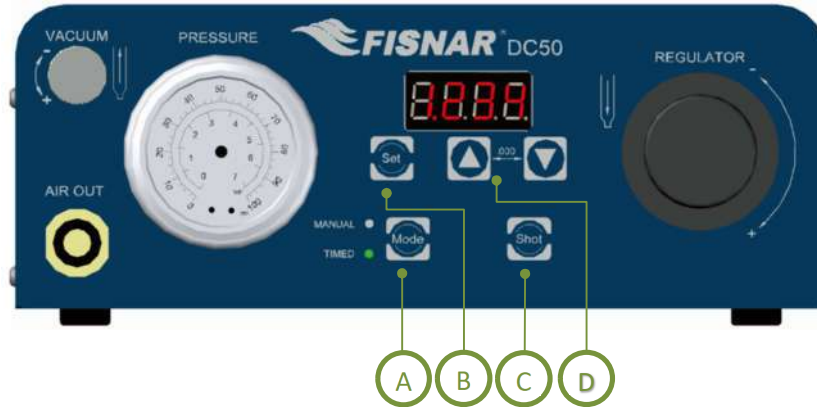



FIG. 8: Dispense Modes

TIMED MODE

1.

Use the  button to switch to TIMED mode.







TIMED mode allows the operator to dispense for a set period, regardless of how long the foot pedal is pressed.

Press the  button to change the current display time. Note that a dispense time can only be set when in TIMED mode.

If the dispense time is being set for the first time the first digit on the left side of the display will start flashing, or else the last digit position changed previously will start flashing.



Note that if the  button or  buttons are not pressed again within 2.5 seconds, the digits will stop flashing and the dispense time showing on the display will be automatically saved.

Press the  buttons to adjust the value (0-9). The digit that is flashing in the display screen is the one that will be adjusted.

	<p>Press the  button again to move to the next digit to the right of the one that was previously flashing. Adjust accordingly to the correct numerical value using the   buttons.</p> <p>Continue to press the  button to scroll through the digit positions, adjusting the numerical values as required.</p> <p>When the  button is pressed when the fourth (last) digit is flashing the first numerical digit will start flashing, allowing you to cycle through the digit positions again, in a continuous cycle.</p> <p>Once the correct dispense time has been set, allow the digits on the display screen to continue flashing. After 2.5 seconds, the digits will stop flashing and the dispense time showing on the display will be automatically saved.</p>
<p>2.</p>	<p>Press the foot pedal or the  button to start the machine and begin dispensing.</p> <p>The digital display will automatically start counting up from 0.000 seconds until it reaches the saved dispense time.</p>
<p>3.</p>	<p>The machine will continue dispensing until the saved dispense time is reached.</p>
<p>4.</p>	<p>When the saved dispense time is reached the machine will automatically stop dispensing.</p>

SETTING A DISPENSE TIME GREATER THAN 9.999 SECONDS.



Use the  button to scroll to the first digit position. use  button to increase the numerical value upwards. Once the numerical value “9” is displayed, press the  button again.

NOTES





The first digital numerical value will change to “1”, the second digit numerical value will change to “0” and the decimal point “.” will automatically move from being displayed after the first digit position to after the second position.

The numerical value that was originally in the second digit position will move to the third digit position, and the numerical value that was originally in the third digit position will move to the fourth (last) digit position.



The numerical value that was originally in the fourth digit position will now not be shown and be disregarded.

REDUCING A DISPENSE TIME FROM GREATER THAN 10.00 SECONDS



Use the  button to scroll to the first digit position. use  button to decrease the numerical value downwards until the numerical value “1” is displayed.



Use the  button to scroll to the second digit position. use  button to decrease the numerical value downwards. Once the numerical value “0” is



reached, press the  button again.

NOTES



The first digital numerical value will automatically change to “9”, the second digit numerical value will change to the numerical value that was originally displayed in the third digit position.

The third digit numerical value will change to the numerical value that was originally displayed in the fourth digit position.

The fourth digit numerical value will change to the numerical value that was originally displayed in the fourth digit position when the dispense time was changed to a dispense time greater than 9.999 seconds.

EXTERNAL MACHINE ACTUATION

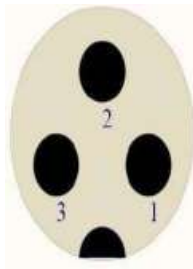
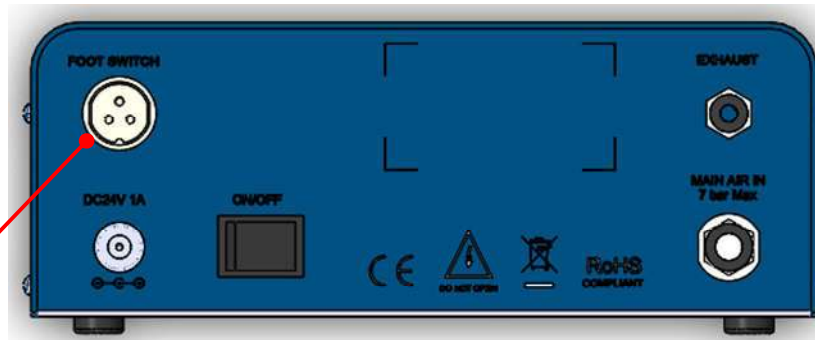

Pin#	Description
1	NOM (Normally Open)
2	COM (Common)
3	

FIG. 9: External Machine Actuation

Input	A dry contact closure (0 Volt) between the Input (Pin #1) and Common (Pin #2) pins will trigger a dispense signal.
	<p>PLEASE READ:</p> <p>Do not apply a voltage between the input pin (1) and the common pin (2). Doing so will damage the control board and void all warranty conditions.</p>

SPARE PARTS LIST

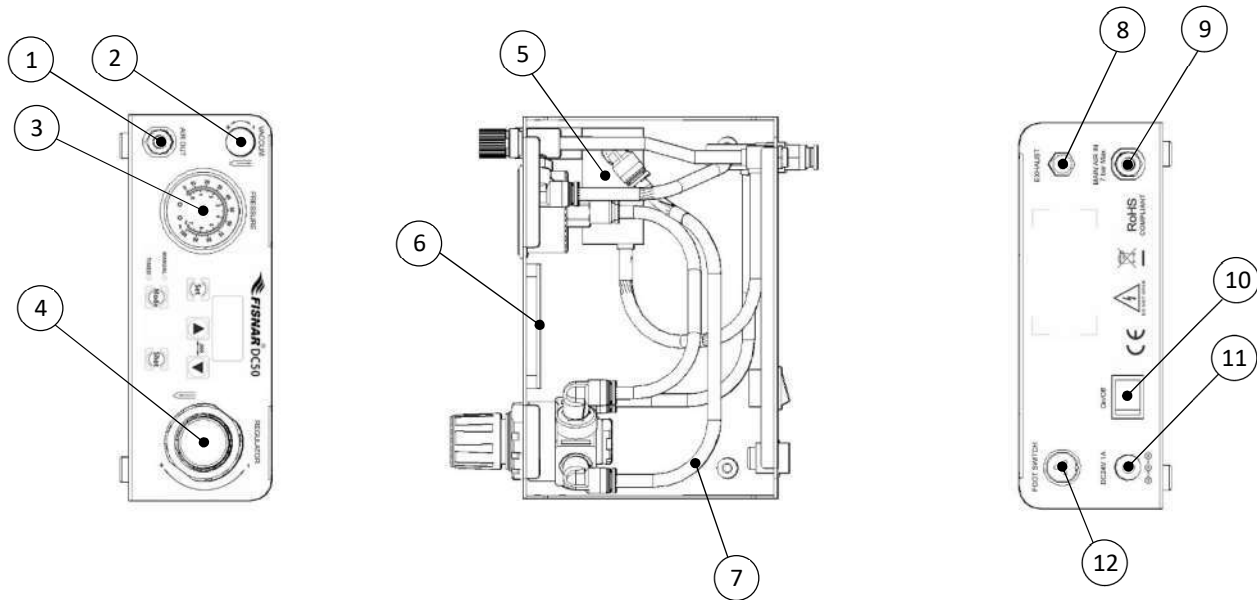

Ref.	Item Number	Description
1	5601900	Air Out Module
2	5601901	Vacuum Control Valve (inc. fittings)
3	5601902	Pressure Gauge (inc. fittings)
4	5601903	Pressure Regulator (inc. fittings)
5	5601904	Solenoid Module (inc. fittings)
6	5601905	Timer Board
7	5601887-10FT	Ø6mm Transparent PU Tubing (10ft)
8	5601906	Vacuum Transducer (inc. fittings)
9	5601940	Air in Module
10	5601908	On/Off Switch Assembly
11	5601909	Power Input Connector Assembly
12	5601910	Foot Switch Connector Assembly
13*	5601911	Power Adaptor (Input: 100 – 240 VAC / Output: 24 VDC)
14*	5601888	Foot Pedal Switch
15*	561851	Air Inlet Hose Assembly
16*	560751LF	Syringe Holder
17*	5779K712	Push to Connect Tube Fitting 1/4" Stem OD X 5/32" Tube OD

*Item Not Shown

LIMITED WARRANTY

Manufacturer warrants this product to the original purchaser for a period of one (1) year from the date of purchase to be free from defects in material and workmanship, but not against damages caused by misuse, negligence, accident, faulty installation, abrasion, corrosion or by not operating in accordance with factory recommendations and instructions. Manufacturer will repair or replace (at factory's option), free of charge, any component of the equipment thus found to be defective, upon prepaid return of the equipment to the factory during the warranty period of the equipment. In no event shall any liability or obligation of Manufacturer arising from this warranty exceed the purchase price of the equipment. **This warranty is valid only when 5 micron filtered air is used.** The manufacturer's written liability, as stated herein, cannot be altered or enlarged except by a written statement signed by an officer of the company. In no event shall manufacturer be liable for consequential or incidental damages. A return authorization is required prior to shipping a defective machine to the factory.

Manufacturer reserves the right to make engineering or product modifications without notice.



info@fisnar.com

www.fisnar.com